

TORNILLO MARIPOSA ZINCADO

Métrica	M-3	M-4	M-5	M-6	M-8	M-10	M-12
L							
6	<input type="checkbox"/>	<input type="checkbox"/>	<input type="checkbox"/>				
8	<input type="checkbox"/>	<input type="checkbox"/>	<input type="checkbox"/>	<input type="checkbox"/>			
10	•	•	•	•	<input type="checkbox"/>		
12	<input type="checkbox"/>	<input type="checkbox"/>	<input type="checkbox"/>	<input type="checkbox"/>	<input type="checkbox"/>		
16	•	•	•	•	•	<input type="checkbox"/>	<input type="checkbox"/>
20	•	•	•	•	•	<input type="checkbox"/>	<input type="checkbox"/>
25	•	•	•	•	•	<input type="checkbox"/>	<input type="checkbox"/>
30	<input type="checkbox"/>	<input type="checkbox"/>	<input type="checkbox"/>	•	•	<input type="checkbox"/>	<input type="checkbox"/>
35	<input type="checkbox"/>	<input type="checkbox"/>	<input type="checkbox"/>	<input type="checkbox"/>	<input type="checkbox"/>	<input type="checkbox"/>	<input type="checkbox"/>
40	<input type="checkbox"/>	<input type="checkbox"/>	<input type="checkbox"/>	<input type="checkbox"/>	<input type="checkbox"/>	<input type="checkbox"/>	<input type="checkbox"/>



• En stock

Consulten plazo de entrega

TIRAFONDO CABEZA HEXAGONAL TORNILLO BARRAQUERO DIN 571 ZINCADO

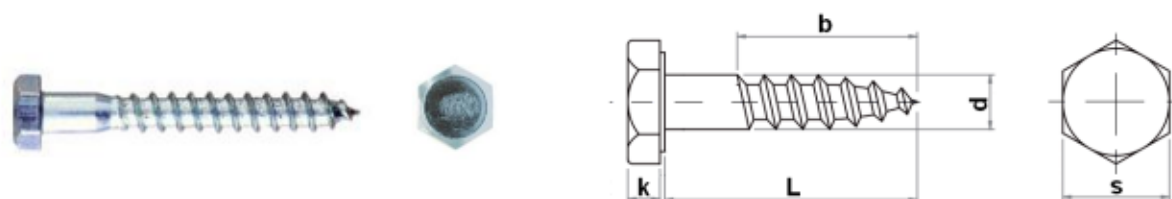

Dimensión	5	6	8	10	12	16
b			$b \geq 6$			
k	3,5	4	5,5	7	8	10
s	8	10	13	17	19	24

L	5	6	8	10	12	16
20	•	•				
25	•	•	•			
30	•	•	•	•		
35	•	•	•	•		
40	•	•	•	•		
45	•	•	•	•		
50	•	•	•	•	•	
60	•	•	•	•	•	
70		□	•	•	•	
80		□	•	•	•	
90		□	□	•	•	□
100		□	□	•	•	□
110		□	□	□	□	
120		□	□	□	□	□

• En stock

□ Consulten plazo de entrega

TORNILLO CABEZA CILÍNDRICA RANURADO

DIN 84 ZINCADO

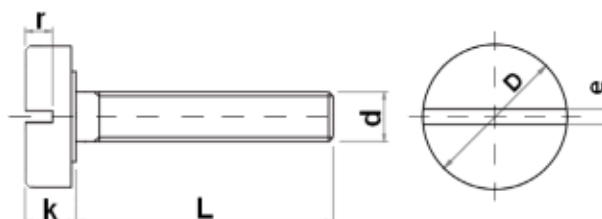

Métrica d	M-2	M-3	M-4	M-5	M-6	M-8
k	1,3	2	2,6	3,3	3,9	5
r	0,6	0,85	1,1	1,3	1,6	2
e	0,5	0,8	1,2	1,2	1,6	2
D	3,8	5,5	7	8,5	10	13
L						
4		□				
5		□				
6	□	•	•	•		
8	□	•	•	•	•	
10	□	•	•	•	•	□
16	□	•	•	•	•	□
20	□	•	•	•	•	□
25		□	•	•	•	□
30		□	•	•	•	□
35		□	□	□	□	□
40		□	□	□	□	□
45		□	□	□	□	□
50		□	□	□	□	□
60			□	□	□	□

• En stock

□ Consulten plazo de entrega

TORNILLO CABEZA AVELLANADA RANURADO

DIN 963 ZINCADO

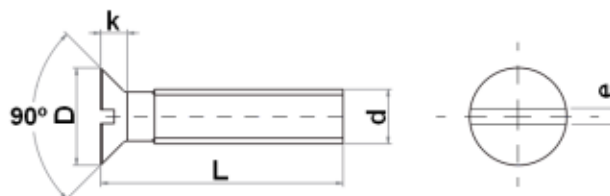

Métrica d	M-3	M-4	M-5	M-6	M-8	M-10	M-12
k	1,65	2,2	2,5	3	4	5	6
D	5,6	7,5	9,2	11	14,5	18	24
e	0,8	1	1,2	1,6	2	2,5	3
L							
6	•	•					
8	•	•	•				
10	•	•	•	•	□		
12	•	•	•	•	□		
16	•	•	•	•	□	□	
20	•	•	•	•	□	□	□
25	□	•	•	•	□	□	□
30	□	•	•	•	□	□	□
35	□	□	□	□	□	□	□
40	□	□	□	□	□	□	□
45	□	□	□	□	□	□	□
50	□	□	□	□	□	□	□
60		□	□	□	□	□	□

• En stock

□ Consulten plazo de entrega

TORNILLO CABEZA AVELANADA "PHILLIPS" DIN 965 ZINCADO

Métrica d	M-3	M-4	M-5	M-6
m	2,9	4,4	4,6	6,6
D	5,6	7,5	9,2	11
k	1,65	2,2	2,5	3
L				
6	•			
8	•	•	•	
10	•	•	•	•
16	•	•	•	•
20	•	•	•	•
25	□	□	•	•
30	□	□	□	□
35	□	□	□	□
40	□	□	□	□
45			□	□
50		□	□	□

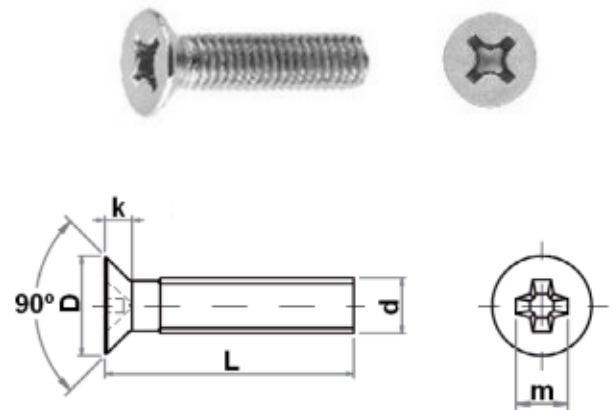

• En stock

□ Consulten plazo de entrega

TORNILLO CABEZA ALOMADA "PHILLIPS" DIN 7985 ZINCADO

Métrica d	M-3	M-4	M-5	M-6
k	2,4	3,1	3,8	4,6
s	3,1	4,6	5,3	6,8
D	6	8	10	12

L				
6	•	•	•	
8	•	•	•	•
10	•	•	•	•
15	•	•	•	•
20	•	•	•	•
25	□	□	•	•
30	□	□	•	•
35	□	□	□	□
40	□	□	□	□

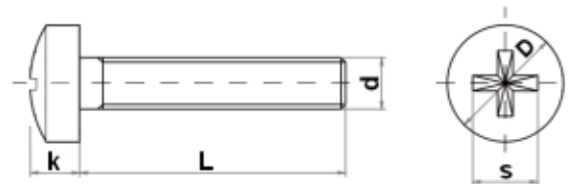
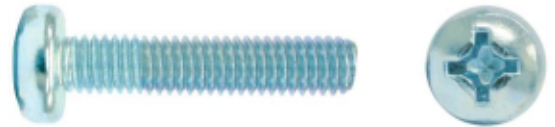

• En stock

□ Consulten plazo de entrega

TORNILLO CABEZA REDONDA RANURADO

DIN 86 ZINCADO

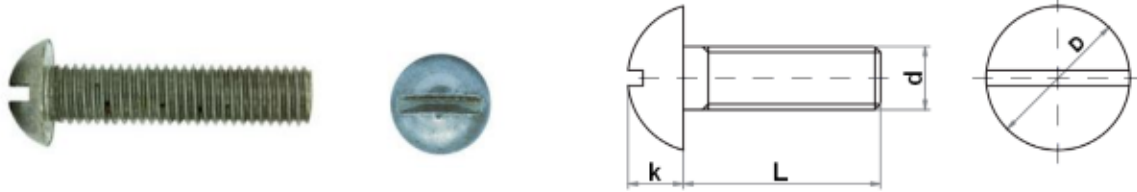

Métrica d	M-3	M-4	M-5	M-6	M-8	M-10
L						
6	•	•				
8	•	•	•			
10	•	•	•	•	□	
15	•	•	•	•	□	□
20	•	•	•	•	□	□
25	□	•	•	•	□	□
30	□	□	□	•	□	□
35	□	□	□	•	□	□
40	□	□	□	•	□	□
45		□	□	□	□	□
50		□	□	□	□	

• En stock

□ Consulten plazo de entrega